



*air*Fiber[®] X Antenna

3 GHz, 26 dBi Slant 45
Antenna for airFiber[®]

Model: AF-3G26-S45

QUICK START GUIDE

Introduction

Thank you for purchasing the Ubiquiti Networks® 3 GHz, 26 dBi Slant 45 Polarity Antenna for airFiber®. This Quick Start Guide is designed to guide you through installation and also includes warranty terms.

Package Contents



Dish Reflector



Antenna Feed



Mounting Bracket



Protective Shroud



Pole Clamps
(Qty. 2)



Stabilizer Brackets
(Qty. 2)



RF Cables
(Qty. 2)



Elevation Rod Assembly



M10x150 Carriage Bolts
(Qty. 4)



M10x100 Carriage Bolts
(Qty. 2)



M10x25 Carriage Bolts
(Qty. 3)



M4 Bolts
(Qty. 4)



Quick Start
Guide

Products may be different from pictures and are subject to change without notice.

TERMS OF USE: Ubiquiti radio devices must be professionally installed. Shielded Ethernet cable and earth grounding must be used as conditions of product warranty. TOUGHcable is designed for outdoor installations. It is the customer's responsibility to follow local country regulations, including operation within legal frequency channels, output power, and Dynamic Frequency Selection (DFS) requirements.

Installation Requirements

- airFiber 3X radio (sold separately)
- Phillips screwdriver
- 16 mm wrench
- 24 mm wrench
- Mounting point:
 - At least 1 m below the highest point on the structure
 - For tower installations, at least 3 m below the top of the tower
- Shielded Category 5 (or above) cabling should be used for all wired Ethernet connections and should be grounded through the AC ground of the PoE.

Hardware Overview

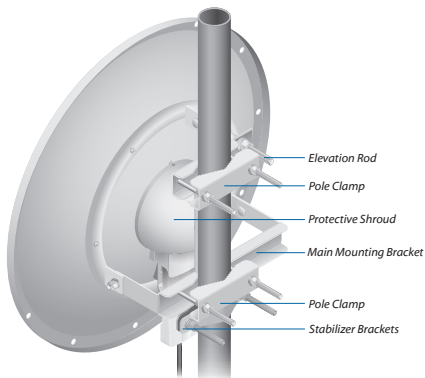

Fully Assembled Back View

Hardware Installation

! **Important:** Handle the *Dish Reflector* with care. Deformations to its shape may degrade performance.

1. The *Dish Reflector* and *Antenna Feed* are keyed so the *Antenna Feed* can only be installed in a single orientation. Attach the *Antenna Feed* to the *Dish Reflector* in the following steps:
 - a. Line up the alignment pin on the *Dish Reflector* with the hole on the *Antenna Feed*.
 - b. Fasten the *Antenna Feed* to the *Dish Reflector* using the four *M4 Bolts*.
 - c. Tighten the four *M4 Bolts*.

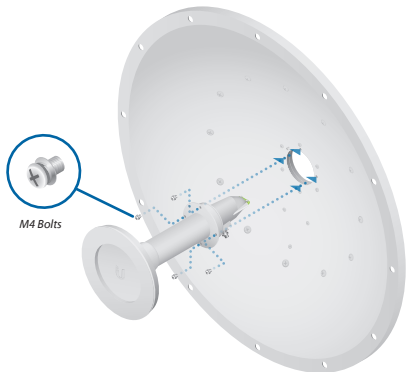

! **Important:** Do not handle the antenna by the *Antenna Feed* once the feed is connected.

2. Remove the nut from the ground bonding point located on the back of the airFiber radio.

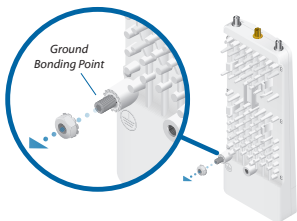

3. Attach a ground wire (min. 10 AWG or 5 mm²) to the lug and replace the nut to secure the wire.

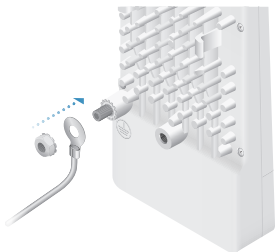

4. At the installation site, secure the other end of the ground wire to a grounded mast, pole, tower, or grounding bar.

! **WARNING:** Failure to properly ground your airFiber radio will void your warranty.

📄 **Note:** The ground wire should be as short as possible and no longer than one meter in length.

5. Attach the *RF Cables* to the connectors labeled **Chain 0** and **Chain 1** on the airFiber radio.



640-00202-01

6. Attach the airFiber radio to the *Dish Reflector*.
 - a. Align the mounting tabs on the back of the airFiber radio with the airFiber radio mount located below the *Antenna Feed*.
 - b. Slide the airFiber radio down to lock it into place.

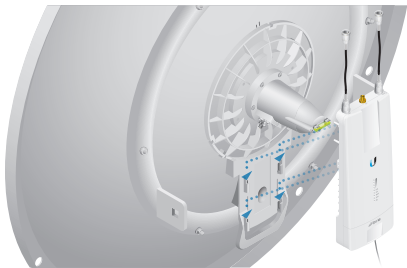

7. Attach the other ends of the *RF Cables* to the RF connectors on the *Antenna Feed*.



8. Attach the GPS antenna (included with the airFiber radio) to the **GPS** connector. Then place the magnetic GPS antenna on the *Dish Reflector* (this is temporary; you will place the GPS antenna on the GPS antenna mount later).

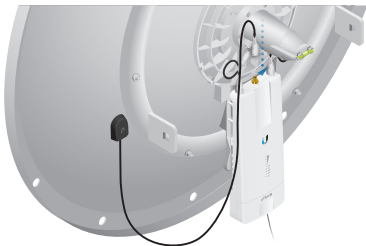

9. Attach the *Protective Shroud*.
- Align the arrow on the top of the shroud with the short hash mark on the *Dish Reflector*.
 - Rotate the shroud clockwise until it aligns with the long hash mark to lock into place.

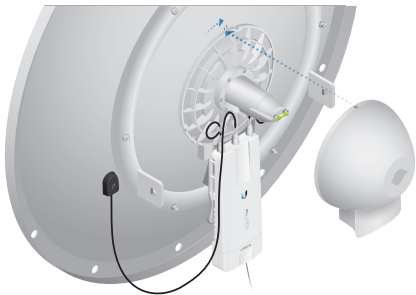

10. The *Elevation Rod Assembly* includes washers and nuts. Remove one washer, one spring lock washer, and one nut. Use them to secure the *Elevation Rod* when assembling.
11. Attach the *Elevation Rod* to the *Mounting Bracket*.
 - a. Insert the *Elevation Rod* into the *Mounting Bracket*.
 - b. Secure the *Elevation Rod* with the washer, spring lock washer, and nut.

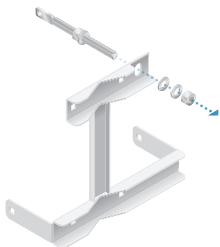

 **Note:** Each *Carriage Bolt* includes a washer, spring lock washer, and nut. Remove these and use them to secure the bolts in the following steps.

12. Insert the four *M10x150 Carriage Bolts* into the *Mounting Bracket*.

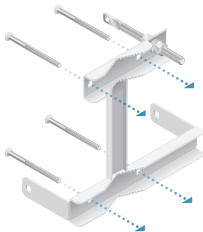

13. Attach the *Dish Reflector* to the *Mounting Bracket*.

- a. Insert one *M10x25 Carriage Bolt* into the *Dish Reflector* and *Elevation Rod*.
- b. Insert two *M10x25 Carriage Bolts* into the *Dish Reflector* and lower section of the *Mounting Bracket*.
- c. Secure each *M10x25 Carriage Bolt* with one washer, one spring lock washer, and one nut.

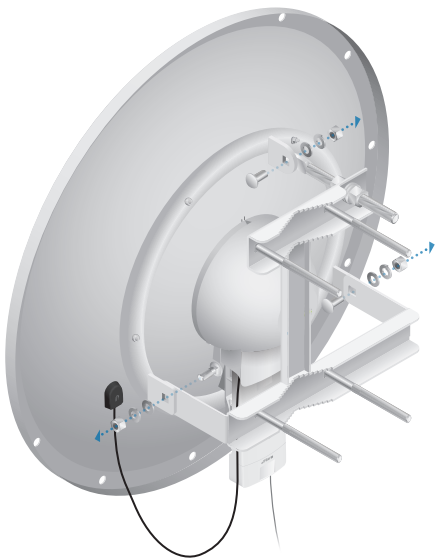

14. Attach the *Stabilizer Brackets* to the pole just beneath the location where the airFiber Antenna will be attached.



Note: The mounting assembly can accommodate a \varnothing 38 - 101 mm pole.

- Place one *Stabilizer Bracket* on each side of the pole.
- Insert the two *M10x100 Carriage Bolts* into the *Stabilizer Brackets*.
- Secure each *M10x100 Carriage Bolt* with one washer, one spring lock washer, and one nut.
- Tighten the nuts to approximately 50 N-m.

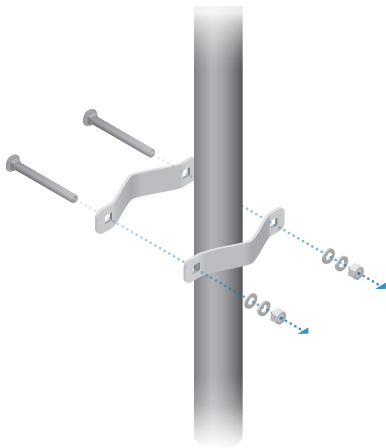

15. Attach the *Mounting Bracket* to the pole just above the *Stabilizer Brackets*.

- a. Slide a *Pole Clamp* over each pair of *M10x150 Carriage Bolts*.
- b. Secure each *Carriage Bolt* with one washer, one spring lock washer, and one nut.



Note: Do not tighten the nuts yet. The antenna should be able to rotate around the pole to allow for azimuth adjustment in the next step.

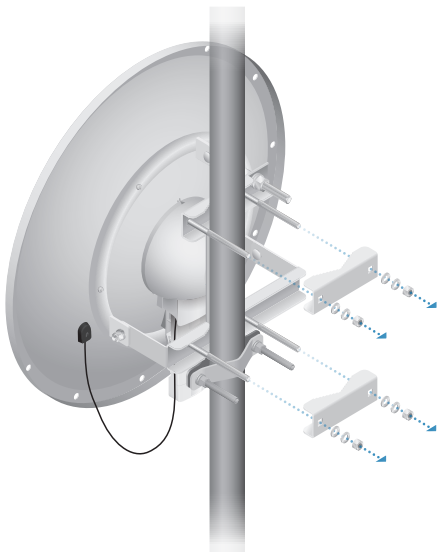

16. Visually align the azimuth and elevation.

- a. To adjust the azimuth, rotate the antenna while it is supported by the *Stabilizer Brackets*.
- b. To adjust the elevation angle, tighten or loosen the nuts on the *Elevation Rod* so that the *Dish Reflector* is set to the desired tilt.
- c. Tighten all bolts and nuts to approximately 50 N-m.

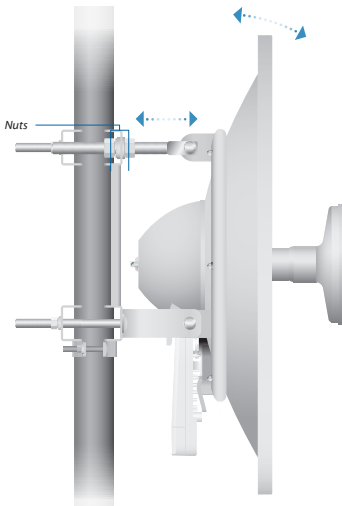

Mounting the GPS Antenna

Locate a mounting point that has a clear view to the sky, and is above and as far away as possible from the antenna.

 **Note:** All GPS items are included with the airFiber radio.

1. Attach the GPS antenna mount to the pole using the metal strap, or attach it to a wall using the appropriate fasteners (not included).

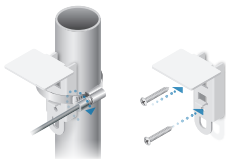

2. Place the GPS antenna on the mount.



3. Secure the cable of the GPS antenna to the mount with a cable tie.



Specifications

| airFiber Antenna AF-3G26-S45 | |
|------------------------------|---|
| Dimensions | 650 x 650 x 300 mm (25.6 x 25.6 x 11.8") |
| Weight | 9.8 kg (21.61 lb) |
| Frequency | 3.3 - 3.8 GHz |
| Gain | 26 dBi |
| HPOL Beamwidth | 7° (6 dB) |
| VPOL Beamwidth | 7° (6 dB) |
| Front-to-Back Ratio | -33 dB |
| Max. VSWR | 1.4:1 |
| Wind Survivability | 200 km/h (125 mph) |
| Wind Loading | 787 N @ 200 km/h (177 lbf @ 125 mph) |
| Polarization | Dual Linear |
| Cross-Pol Isolation | 35 dB Min. |
| ETSI Specification | EN 302 326 DN2 |
| Mounting | Universal Pole Mount, airFiber Radio Mount, and Weatherproof RF Jumpers Included |

Safety Notices

1. Read, follow, and keep these instructions.
2. Heed all warnings.
3. Only use attachments/accessories specified by the manufacturer.



WARNING: Do not use this product in location that can be submerged by water.



WARNING: Avoid using this product during an electrical storm. There may be a remote risk of electric shock from lightning.

Electrical Safety Information

1. Compliance is required with respect to voltage, frequency, and current requirements indicated on the manufacturer's label. Connection to a different power source than those specified may result in improper operation, damage to the equipment or pose a fire hazard if the limitations are not followed.
2. There are no operator serviceable parts inside this equipment. Service should be provided only by a qualified service technician.

Limited Warranty

UBIQUITI NETWORKS, Inc (“UBIQUITI NETWORKS”) warrants that the product(s) furnished hereunder (the “Product(s)”) shall be free from defects in material and workmanship for a period of one (1) year from the date of shipment by UBIQUITI NETWORKS under normal use and operation. UBIQUITI NETWORKS’ sole and exclusive obligation and liability under the foregoing warranty shall be for UBIQUITI NETWORKS, at its discretion, to repair or replace any Product that fails to conform to the above warranty during the above warranty period. The expense of removal and reinstallation of any Product is not included in this warranty. The warranty period of any repaired or replaced Product shall not extend beyond its original term.

Warranty Conditions

The above warranty does not apply if the Product:

- (I) has been modified and/or altered, or an addition made thereto, except by Ubiquiti Networks, or Ubiquiti Networks’ authorized representatives, or as approved by Ubiquiti Networks in writing;
- (II) has been painted, rebranded or physically modified in any way;
- (III) has been damaged due to errors or defects in cabling;
- (IV) has been subjected to misuse, abuse, negligence, abnormal physical, electromagnetic or electrical stress, including lightning strikes, or accident;
- (V) has been damaged or impaired as a result of using third party firmware;
- (VI) has no original Ubiquiti MAC label, or is missing any other original Ubiquiti label(s); or
- (VII) has not been received by Ubiquiti within 30 days of issuance of the RMA.

In addition, the above warranty shall apply only if: the product has been properly installed and used at all times in accordance, and in all material respects, with the applicable Product documentation; all Ethernet cabling runs use CAT5 (or above), and for outdoor installations, shielded Ethernet cabling is used, and for indoor installations, indoor cabling requirements are followed.

Returns

No Products will be accepted for replacement or repair without obtaining a Return Materials Authorization (RMA) number from UBIQUITI NETWORKS during the warranty period, and the Products being received at UBIQUITI NETWORKS' facility freight prepaid in accordance with the RMA process of UBIQUITI NETWORKS. Products returned without an RMA number will not be processed and will be returned freight collect or subject to disposal. Information on the RMA process and obtaining an RMA number can be found at: www.ubnt.com/support/warranty.

Disclaimer

EXCEPT FOR ANY EXPRESS WARRANTIES PROVIDED HEREIN, UBIQUITI NETWORKS, ITS AFFILIATES, AND ITS AND THEIR THIRD PARTY DATA, SERVICE, SOFTWARE AND HARDWARE PROVIDERS HEREBY DISCLAIM AND MAKE NO OTHER REPRESENTATION OR WARRANTY OF ANY KIND, EXPRESS, IMPLIED OR STATUTORY, INCLUDING, BUT NOT LIMITED TO, REPRESENTATIONS, GUARANTEES, OR WARRANTIES OF MERCHANTABILITY, ACCURACY, QUALITY OF SERVICE OR RESULTS, AVAILABILITY, SATISFACTORY QUALITY, LACK OF VIRUSES, QUIET ENJOYMENT, FITNESS FOR A PARTICULAR PURPOSE AND NON-INFRINGEMENT AND ANY WARRANTIES ARISING FROM ANY COURSE OF DEALING, USAGE OR TRADE PRACTICE IN CONNECTION WITH SUCH PRODUCTS AND SERVICES. BUYER ACKNOWLEDGES THAT NEITHER UBIQUITI NETWORKS NOR ITS THIRD PARTY PROVIDERS CONTROL BUYER'S EQUIPMENT OR THE TRANSFER OF DATA OVER COMMUNICATIONS FACILITIES, INCLUDING THE INTERNET, AND THAT THE PRODUCTS AND SERVICES MAY BE SUBJECT TO LIMITATIONS, INTERRUPTIONS, DELAYS, CANCELLATIONS AND OTHER PROBLEMS INHERENT IN THE USE OF COMMUNICATIONS FACILITIES. UBIQUITI NETWORKS, ITS AFFILIATES AND ITS AND THEIR THIRD PARTY PROVIDERS ARE NOT RESPONSIBLE FOR ANY INTERRUPTIONS, DELAYS, CANCELLATIONS, DELIVERY FAILURES, DATA LOSS, CONTENT CORRUPTION, PACKET LOSS, OR OTHER DAMAGE RESULTING FROM ANY OF THE FOREGOING. In addition, UBIQUITI NETWORKS does not warrant that the operation of the Products will be error-free or that operation will be uninterrupted. In no event shall UBIQUITI NETWORKS be responsible for damages or claims of any nature or description relating to system performance, including coverage, buyer's selection of products (including the Products) for buyer's application and/or failure of products (including the Products) to meet government or regulatory requirements.

Limitation of Liability

EXCEPT TO THE EXTENT PROHIBITED BY LOCAL LAW, IN NO EVENT WILL UBIQUITI OR ITS SUBSIDIARIES, AFFILIATES OR SUPPLIERS BE LIABLE FOR DIRECT, SPECIAL, INCIDENTAL, CONSEQUENTIAL OR OTHER DAMAGES (INCLUDING LOST PROFIT, LOST DATA, OR DOWNTIME COSTS), ARISING OUT OF THE USE, INABILITY TO USE, OR THE RESULTS OF USE OF THE PRODUCT, WHETHER BASED IN WARRANTY, CONTRACT, TORT OR OTHER LEGAL THEORY, AND WHETHER OR NOT ADVISED OF THE POSSIBILITY OF SUCH DAMAGES.

Note

Some countries, states and provinces do not allow exclusions of implied warranties or conditions, so the above exclusion may not apply to you. You may have other rights that vary from country to country, state to state, or province to province. Some countries, states and provinces do not allow the exclusion or limitation of liability for incidental or consequential damages, so the above limitation may not apply to you. EXCEPT TO THE EXTENT ALLOWED BY LOCAL LAW, THESE WARRANTY TERMS DO NOT EXCLUDE, RESTRICT OR MODIFY, AND ARE IN ADDITION TO, THE MANDATORY STATUTORY RIGHTS APPLICABLE TO THE LICENSE OF ANY SOFTWARE (EMBEDDED IN THE PRODUCT) TO YOU. The United Nations Convention on Contracts for the International Sale of Goods shall not apply to any transactions regarding the sale of the Products.

Compliance

RF Exposure Warning

The antenna and transmitter must be installed to provide a separation distance from all persons and must not be located or operating in conjunction with any other antenna or transmitter. For the specific separation distance, refer to the User Guide for your airFiber radio (transmitter).

L'antenne et l'émetteur doit être installé pour fournir une distance de séparation de toute les personnes et ne doit pas être situé ou opérant en conjonction avec une autre antenne ou un autre émetteur. Pour la distance spécifique de séparation, se référer au Guide de démarrage rapide pour votre appareil airFiber radio (l'émetteur).

RoHS/WEEE Compliance Statement



English

European Directive 2002/96/EC requires that the equipment bearing this symbol on the product and/or its packaging must not be disposed of with unsorted municipal waste. The symbol indicates that this product should be disposed of separately from regular household waste streams. It is your responsibility to dispose of this and other electric and electronic equipment via designated collection facilities appointed by the government or local authorities. Correct disposal and recycling will help prevent potential negative consequences to the environment and human health. For more detailed information about the disposal of your old equipment, please contact your local authorities, waste disposal service, or the shop where you purchased the product.

Deutsch

Die Europäische Richtlinie 2002/96/EC verlangt, dass technische Ausrüstung, die direkt am Gerät und/oder an der Verpackung mit diesem Symbol versehen ist, nicht zusammen mit unsortiertem Gemeindeabfall entsorgt werden darf. Das Symbol weist darauf hin, dass das Produkt von regulärem Haushaltsmüll getrennt entsorgt werden sollte. Es liegt in Ihrer Verantwortung, dieses Gerät und andere elektrische und elektronische Geräte über die dafür zuständigen und von der Regierung oder örtlichen Behörden dazu bestimmten Sammelstellen zu entsorgen. Ordnungsgemäßes Entsorgen und Recyceln trägt dazu bei, potentielle negative Folgen für Umwelt und die menschliche Gesundheit zu vermeiden. Wenn Sie weitere Informationen zur Entsorgung Ihrer Altgeräte benötigen, wenden Sie sich bitte an die örtlichen Behörden oder städtischen Entsorgungsdienste oder an den Händler, bei dem Sie das Produkt erworben haben.

Español

La Directiva 2002/96/CE de la UE exige que los equipos que lleven este símbolo en el propio aparato y/o en su embalaje no deben eliminarse junto con otros residuos urbanos no seleccionados. El símbolo indica que el producto en cuestión debe separarse de los residuos domésticos convencionales con vistas a su eliminación. Es responsabilidad suya desechar este y cualesquiera otros aparatos eléctricos y electrónicos a través de los puntos de recogida que ponen a su disposición el gobierno y las autoridades locales. Al desechar y reciclar correctamente estos aparatos estará contribuyendo a evitar posibles consecuencias negativas para el medio ambiente y la salud de las personas. Si desea obtener información más detallada sobre la eliminación segura de su aparato usado, consulte a las autoridades locales, al servicio de recogida y eliminación de residuos de su zona o pregunte en la tienda donde adquirió el producto.

Français

La directive européenne 2002/96/CE exige que l'équipement sur lequel est apposé ce symbole sur le produit et/ou son emballage ne soit pas jeté avec les autres ordures ménagères. Ce symbole indique que le produit doit être éliminé dans un circuit distinct de celui pour les déchets des ménages. Il est de votre responsabilité de jeter ce matériel ainsi que tout autre matériel électrique ou électronique par les moyens de collecte indiqués par le gouvernement et les pouvoirs publics des collectivités territoriales. L'élimination et le recyclage en bonne et due forme ont pour but de lutter contre l'impact néfaste potentiel de ce type de produits sur l'environnement et la santé publique. Pour plus d'informations sur le mode d'élimination de votre ancien équipement, veuillez prendre contact avec les pouvoirs publics locaux, le service de traitement des déchets, ou l'endroit où vous avez acheté le produit.

Italiano

La direttiva europea 2002/96/EC richiede che le apparecchiature contrassegnate con questo simbolo sul prodotto e/o sull'imballaggio non siano smaltite insieme ai rifiuti urbani non differenziati. Il simbolo indica che questo prodotto non deve essere smaltito insieme ai normali rifiuti domestici. È responsabilità del proprietario smaltire sia questi prodotti sia le altre apparecchiature elettriche ed elettroniche mediante le specifiche strutture di raccolta indicate dal governo o dagli enti pubblici locali. Il corretto smaltimento ed il riciclaggio aiuteranno a prevenire conseguenze potenzialmente negative per l'ambiente e per la salute dell'essere umano. Per ricevere informazioni più dettagliate circa lo smaltimento delle vecchie apparecchiature in Vostro possesso, Vi invitiamo a contattare gli enti pubblici di competenza, il servizio di smaltimento rifiuti o il negozio nel quale avete acquistato il prodotto.

Declaration of Conformity

| | |
|-------------------------|--|
| Česky [Czech] | UBIQUITI NETWORKS tímto prohlašuje, že toto UBIQUITI NETWORKS zařízení, je ve shod se základními požadavky a dalšími příslušnými ustanoveními směrnice 1999/5/ES. |
| Dansk [Danish] | Hermed, UBIQUITI NETWORKS, erklærer at denne UBIQUITI NETWORKS enhed, er i overensstemmelse med de væsentlige krav og øvrige relevante krav i direktiv 1999/5/EF. |
| Nederlands [Dutch] | Hierbij verklaart UBIQUITI NETWORKS, dat deze UBIQUITI NETWORKS apparaat, in overeenstemming is met de essentiële eisen en de andere relevante bepalingen van richtlijn 1999/5/EC. |
| English | Hereby, UBIQUITI NETWORKS, declares that this UBIQUITI NETWORKS device, is in compliance with the essential requirements and other relevant provisions of Directive 1999/5/EC. |
| Eesti [Estonian] | Käesolevaga UBIQUITI NETWORKS kinnitab, et antud UBIQUITI NETWORKS seade, on vastavus olulistele nõuetele ja teistele asjakohastele sätetele direktiivi 1999/5/EÜ. |
| Suomi [Finnish] | Täten UBIQUITI NETWORKS vakuuttaa, että tämä UBIQUITI NETWORKS laite, on yhdenmukainen olennaisten vaatimusten ja muiden sitä koskevien direktiivin 1999/5/EY. |
| Français [French] | Par la présente UBIQUITI NETWORKS déclare que l'appareil UBIQUITI NETWORKS, est conforme aux exigences essentielles et aux autres dispositions pertinentes de la directive 1999/5/CE. |
| Deutsch [German] | Hiermit erklärt UBIQUITI NETWORKS, dass sich dieses UBIQUITI NETWORKS Gerät, in Übereinstimmung mit den grundlegenden Anforderungen und den anderen relevanten Vorschriften der Richtlinie 1999/5/EG befindet. |
| Ελληνική [Greek] | Δια του παρόντος, UBIQUITI NETWORKS, δηλώνει ότι αυτή η συσκευή UBIQUITI NETWORKS, είναι σε συμμόρφωση με τις βασικές απαιτήσεις και τις λοιπές σχετικές διατάξεις της οδηγίας 1995/5/EK. |
| Magyar [Hungarian] | Ezennel UBIQUITI NETWORKS kijelenti, hogy ez a UBIQUITI NETWORKS készülék megfelel az alapvető követelményeknek és más vonatkozó 1999/5/EK irányelv rendelkezéseit. |
| Íslenska [Icelandic] | Hér, UBIQUITI NETWORKS, því yfir að þetta UBIQUITI NETWORKS tæki er í samræmi við grunnkröfur og önnur viðeigandi ákvæði tilskipun 1999/5/EC. |
| Italiano [Italian] | Con la presente, UBIQUITI NETWORKS, dichiara che questo dispositivo UBIQUITI NETWORKS, è conforme ai requisiti essenziali ed alle altre disposizioni pertinenti della direttiva 1999/5/CE. |

| | |
|-----------------------------|--|
| Latviski [Latvian] | Ar šo, UBIQUITI NETWORKS, deklarē, ka UBIQUITI NETWORKS ierīce, ir saskaņā ar būtiskajām prasībām un citiem attiecīgiem noteikumiem Direktīvā 1999/5/EK. |
| Lietuviškai [Lithuanian] | UBIQUITI NETWORKS deklaruoja, kad šis UBIQUITI NETWORKS įrenginys atitinka esminius reikalavimus ir kitas 1999/5/EB Direktyvos nuostatas. |
| Malti [Maltese] | Hawnhekk, UBIQUITI NETWORKS, tiddikjara li dan il-mezz UBIQUITI NETWORKS huwa konformi mar-rekwiżiti essenzjali u dispożizzjonijiet rilevanti oħrajn ta 'Direttiva 1999/5/EC. |
| Norsk [Norwegian] | Herved UBIQUITI NETWORKS, erklærer at denne UBIQUITI NETWORKS enheten, er i samsvar med de grunnleggende kravene og andre relevante bestemmelser i direktiv 1999/5/EF. |
| Slovensky [Slovak] | Týmto UBIQUITI NETWORKS, prehlasuje, že toto UBIQUITI NETWORKS zariadenie, je v súlade so základnými požiadavkami a ďalšími relevantnými ustanoveniami smernice 1999/5/ES. |
| Svenska [Swedish] | Härmed UBIQUITI NETWORKS, intygar att denna UBIQUITI NETWORKS enhet är i överensstämmelse med de väsentliga egenskapskrav och övriga relevanta bestämmelser som framgår av direktiv 1999/5/EG. |
| Español [Spanish] | Por medio de la presente UBIQUITI NETWORKS declara que este dispositivo UBIQUITI NETWORKS, cumple con los requisitos esenciales y cualesquiera otras disposiciones aplicables o exigibles de la Directiva 1999/5/CE. |
| Polski [Polish] | Niniejszym, Ubiquiti Networks, oświadcza, że urządzenie UBIQUITI NETWORKS, jest zgodny z zasadniczymi wymaganiami oraz pozostałymi stosownymi postanowieniami Dyrektywy 1999/5/EC. |
| Português [Portuguese] | UBIQUITI NETWORKS declara que este dispositivo UBIQUITI NETWORKS, está conforme com os requisitos essenciais e outras disposições da Directiva 1999/5/CE. |
| Română [Romanian] | Prin prezenta, UBIQUITI NETWORKS declară că acest dispozitiv UBIQUITI NETWORKS este în conformitate cu cerințele esențiale și alte prevederi relevante ale Directivei 1999/5/CE. |

Online Resources

Support support.ubnt.com

Community community.ubnt.com

Downloads downloads.ubnt.com

